

Mit Freude lernen!

Michael Junga

Lernpaket

Wörtersuchrätsel zur Steigerung der Lese- und Wahrnehmungskompetenz

Für Grundschul Kinder
ab Klasse 2

Für Förderschul Kinder
ab Klasse 3



Wörtersuchrätsel

Zielgruppen

Grundschule: ab Klasse 2
Förderschule: ab Klasse 3

Förderschwerpunkt

Sprachliches Denktraining, visuelles Wahrnehmungstraining
(Schwerpunkt: Figur-Grund-Wahrnehmung)

Aufgabe

Die Kinder sollen jeweils elf Wörter in einem Buchstabengewirr entdecken, diese Wörter markieren und dann in eine vorgegebene Tabelle eintragen.









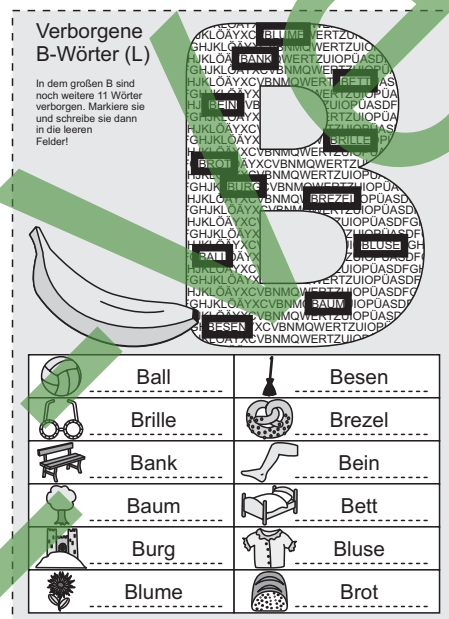



Folgende Wörtergruppen werden behandelt:

- A-Wörter
- B-Wörter
- D-Wörter
- E-Wörter
- F-Wörter
- G-Wörter
- H-Wörter
- K-Wörter
- M-Wörter
- O-Wörter
- P-Wörter
- R-Wörter
- S-Wörter
- T-Wörter
- W-Wörter
- Z-Wörter

Verborgene B-Wörter (L)

In dem großen B sind noch weitere 11 Wörter verborgen. Markiere sie und schreibe sie dann in die leeren Felder!



| | | | |
|---|--------|---|--------|
|  | Ball |  | Besen |
|  | Brille |  | Brezel |
|  | Bank |  | Bein |
|  | Baum |  | Bett |
|  | Burg |  | Bluse |
|  | Blume |  | Brot |

Nutzen

Die Kinder stärken ihre sprachliche Denk- und Kombinationsfähigkeit, ihr Lesevermögen, ihre visuelle Wahrnehmungsfähigkeit sowie ihr allgemeines Konzentrationsvermögen.

Wörtersuchrätsel

Einsatzmöglichkeiten

Es gibt vielfältige Möglichkeiten, dieses Material im Unterricht einzusetzen. Hier einige Beispiele:

- Im Rahmen des regulären Deutschunterrichts, wenn die Themenstellung es zulässt;
- als Zeitausgleich für schneller arbeitende Schüler, die sinnvoll beschäftigt werden wollen;
- als Hausaufgabe, die aus dem Unterricht erwächst und zu ihm zurückführt;
- im Rahmen von Wochenplanarbeit, Stationenlernen, Förderunterricht usw.

Materialumfang

- 2 Informationsseiten,
- 16 Übungsvorlagen,
- 16 Lösungsvorlagen.

Viel Freude mit diesem Material wünscht Ihnen jetzt der Autor
Michael Junga aus Braunschweig



Name: _____









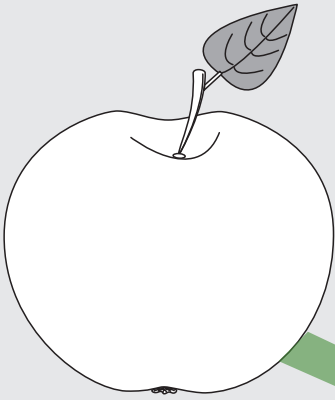

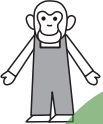
Klasse: _____

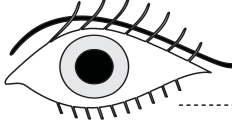
Datum: _____

Verborgene A-Wörter

In dem großen A sind noch weitere 11 Wörter verborgen. Markiere sie und schreibe sie dann in die leeren Felder!



| | | | |
|---|-------|--|-------|
|  | Affe |  | _____ |
|  | _____ |  | _____ |
|  | _____ |  | _____ |
|  | _____ |  | _____ |
|  | _____ |  | _____ |
|  | _____ |  | _____ |



Name: _____









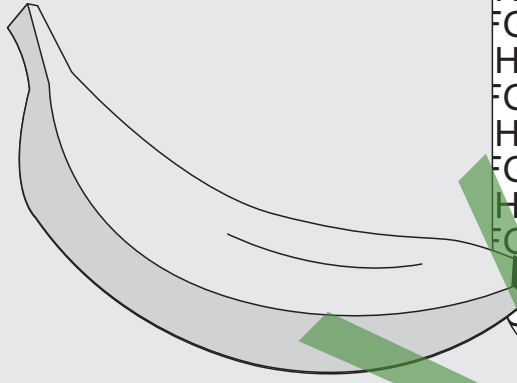

Klasse: _____

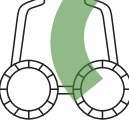
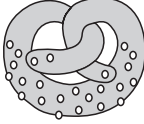
Datum: _____

Verborgene B-Wörter

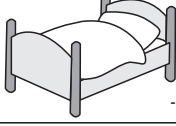
In dem großen B sind noch weitere 11 Wörter verborgen. Markiere sie und schreibe sie dann in die leeren Felder!



| | | | |
|---|-------------|--|-------|
|  | Ball |  | |
|  | |  | |
|  | |  | |
|  | |  | |
|  | |  | |
|  | |  | |



Name: _____









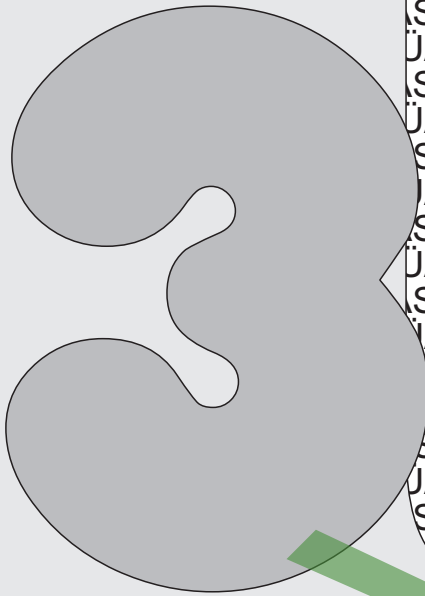

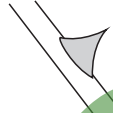

Klasse: _____

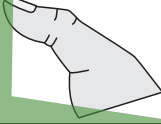
Datum: _____

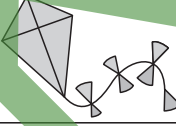
Verborgene D-Wörter

In dem großen D sind noch weitere 11 Wörter verborgen. Markiere sie und schreibe sie dann in die leeren Felder!



| | | |
|---|-------------|--|
|  | Dorn |  |
|  | |  |
|  | |  |
|  | |  |
|  | |  |
|  | |  |



Name:

Klasse:

Datum:

Verborgene E-Wörter

In dem großen E sind noch weitere 11 Wörter verborgen. Markiere sie und schreibe sie dann in die leeren Felder!

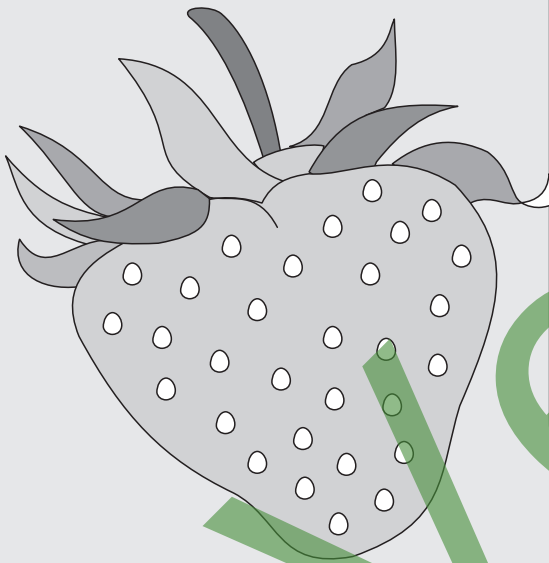

RTZUENGLASDFGHJKLÖÄYXC
 RTZUIOPÜASDFGHJKLÖÄYXCVB
 ERTZUIOPÜASDFGHJKLÖÄYXC
 RTZUIOPÜASDFGHJKLÖÄYXCVB
 VERTERDEPÜASDFGHJKLÖÄYX
 RTZUIOPÜASDFGHJKLÖÄYXC
 VERTZUIOPÜASDFGHJKLÖÄYXC
 RTZUIOPÜASDFGHJKLÖÄYXC
 VERELCHOPÜASDFGHJKLÖÄYXC
 RTZUIOPÜASDFGHJKLÖÄYXC
 VENTZUIOPÜASDFGHJKLÖÄYXC
 RTZUIOPÜASDFGHJKLÖÄYXC
 VERTZUIOERBSENGHJKLÖÄYXC
 RTZUIOPÜASDFGHJKLÖÄYXC
 VERTZUIOPÜASDFGHJKLÖÄYXC
 RTZUIOPÜASDFGHJKLÖÄYXC
 VEREFELFANTA
 RTZUIOPÜASDFGHJKLÖÄYXC
 VERTZUIOPÜASDFGHJKLÖÄYXC
 RTZUIOPÜASDFGHJKLÖÄYXC
 VESKIMODFG
 RTZUIOPÜASDFGHJKLÖÄYXC
 VERTZUIOPÜASDFGHJKLÖÄYXC
 RTZESSELÜASDFGHJKLÖÄYXC
 VERTZUIOPÜASDFGHJKLÖÄYXC
 RTZUIOPÜASDFGHJKLÖÄYXC
 RTZUWELSTERDFGHJKLÖÄYXC

| | | | |
|--|-------|--|-------|
| | Essig | | |
| | | | |
| | | | |
| | | | |
| | | | |
| | | | |



Name: _____

Klasse: _____

Datum: _____

Verborgene F-Wörter

In dem großen F sind noch weitere 11 Wörter verborgen. Markiere sie und schreibe sie dann in die leeren Felder!

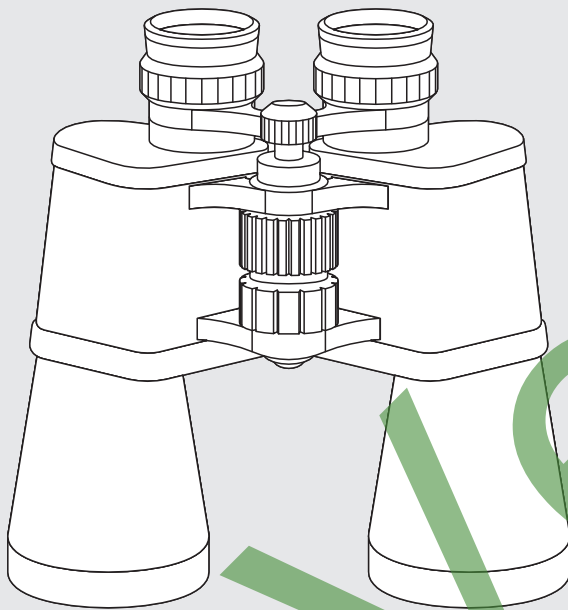

PÜASDFGHJKLOÄYXCVB
PÜFISCHHJKLÖÄYXCVBNMQ
UIOPÜASDFFAHNEÄYXCVBNMQ
OPÜASDFGHJKLÖÄYXFEUERQV
UIOPÜASDFGHJKLÖÄYXCVBNM
OPFAHRRADJKLÖÄYXCVBNM
UIOPÜASDF
OPÜASDFGH
UFUCHSÜDF
OPÜASDFGH
UIOPÜASDF
OPÜASDFGHJKLÖÄYXCVBNM
UIOPÜASDFGFRAUÖÄYXCVB
OFENSTERPKLOÄYXCVBNMQV
UIOPÜASDFGHJKLÖFLIEGENM
OPÜASDFROSCHÖÄYXCVBNM
UIOPÜASDFGHJKLÖÄYXCVB
OPÜASDFGH
UIOPÜASDF
OPÜASDFGH
UIFLASCHEF
OPÜASDFGH
UIOFADENF
OPÜASDFGH
UIFEDERDF
OPÜASDFGH
UIOPÜASDF
PÜASDF



Frau

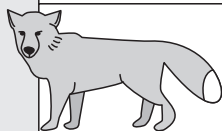
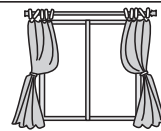
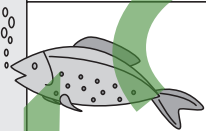
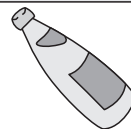



Name: _____









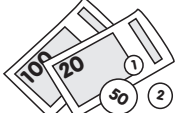

Klasse: _____

Datum: _____

Verborgene G-Wörter

In dem großen G sind noch weitere 11 Wörter verborgen. Markiere sie und schreibe sie dann in die leeren Felder!



| | | | |
|---|--------------|--|-------|
|  | Grube |  | |
|  | |  | |
|  | |  | |
|  | |  | |
|  | |  | |
|  | |  | |



Name: _____

Klasse: _____

Datum: _____

Verborgene H-Wörter

In dem großen H sind noch weitere 11 Wörter verborgen. Markiere sie und schreibe sie dann in die leeren Felder!

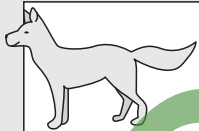
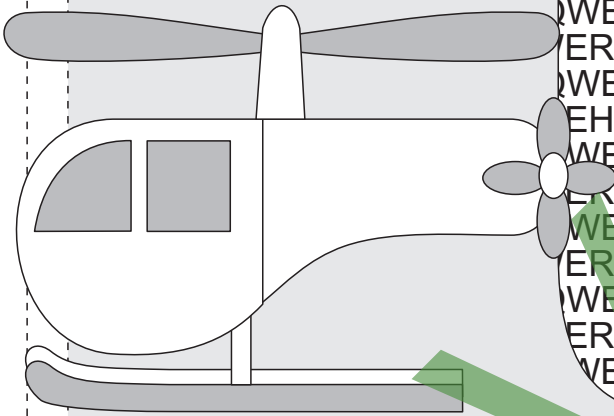

Hund

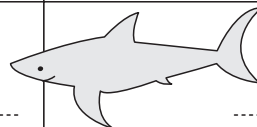
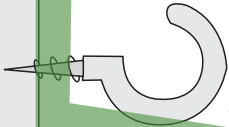

.....

.....

.....

.....

.....

.....

.....

.....

.....

.....

.....

.....



Name: _____









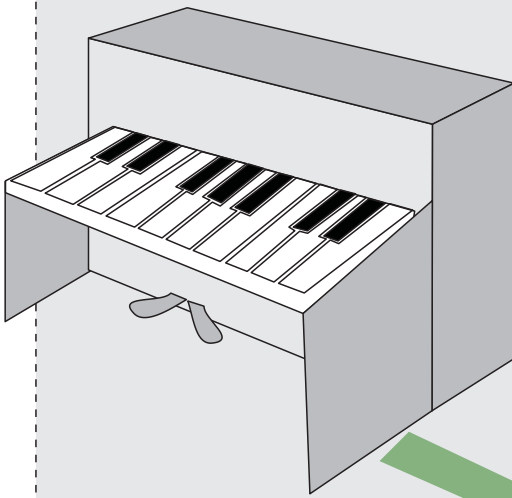

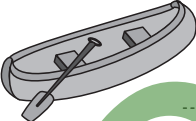
Klasse: _____

Datum: _____

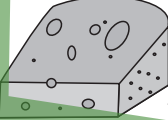
Verborgene K-Wörter

In dem großen K sind noch weitere 11 Wörter verborgen. Markiere sie und schreibe sie dann in die leeren Felder!

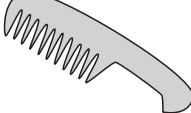
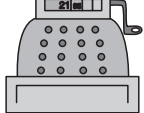

| | | | |
|---|-------|---|-------|
|  | Kanu |  | _____ |
|  | _____ |  | _____ |
|  | _____ |  | _____ |
|  | _____ |  | _____ |
|  | _____ |  | _____ |
|  | _____ |  | _____ |



Name: _____









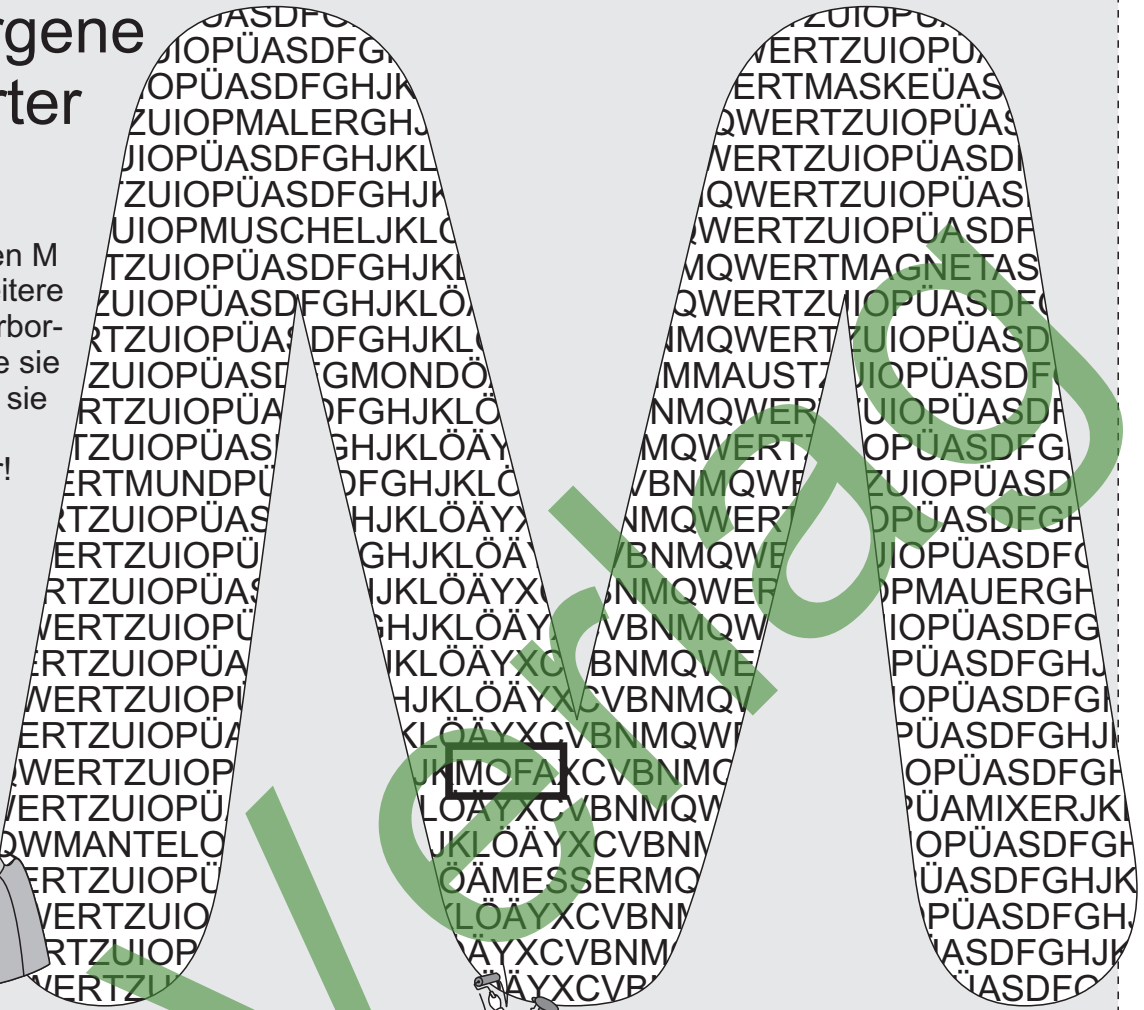
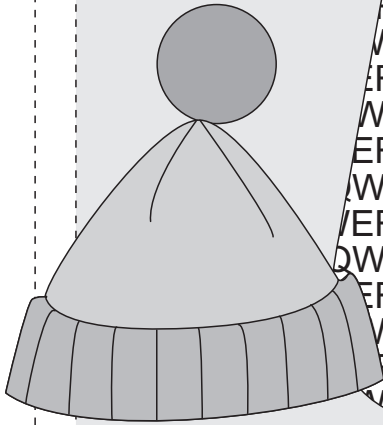

Klasse: _____

Datum: _____

Verborgene M-Wörter

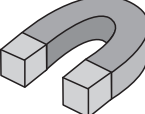
In dem großen M sind noch weitere 11 Wörter verborgen. Markiere sie und schreibe sie dann in die leeren Felder!

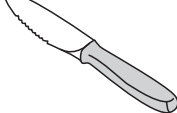

| | | | |
|---|-------|--|-------|
|  | Mofa |  | |
|  | |  | |
|  | |  | |
|  | |  | |
|  | |  | |
|  | |  | |



Name:

Klasse:

Datum:

Verborgene N-Wörter

In dem großen N sind noch weitere 11 Wörter verborgen. Markiere sie und schreibe sie dann in die leeren Felder!

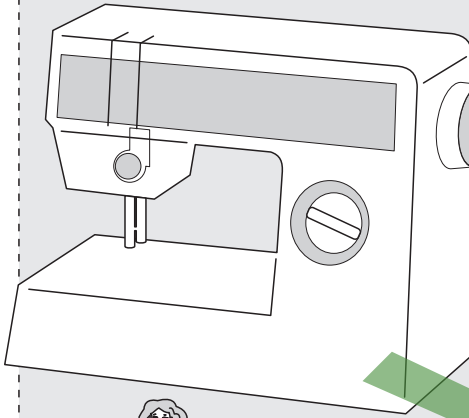

Nixe

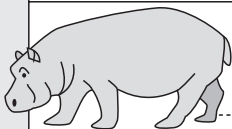
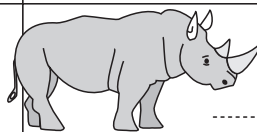
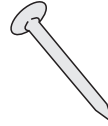



Name: _____









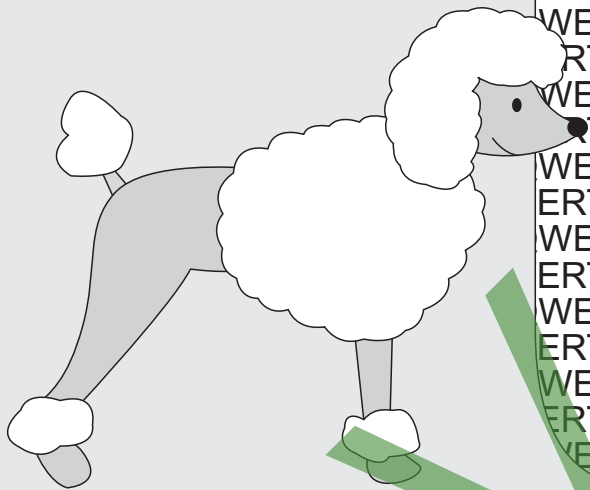

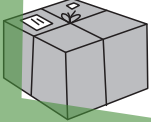

Klasse: _____

Datum: _____

Verborgene P-Wörter

In dem großen P sind noch weitere 11 Wörter verborgen. Markiere sie und schreibe sie dann in die leeren Felder!



| | | | |
|---|-----------------|--|-------|
|  | Polizist |  | |
|  | |  | |
|  | |  | |
|  | |  | |
|  | |  | |
|  | |  | |



Name: _____







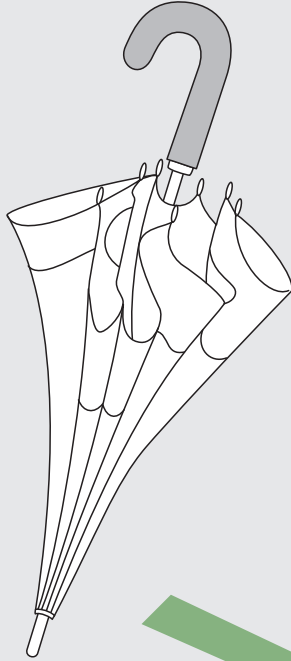

Klasse: _____

Datum: _____

Verborgene R-Wörter

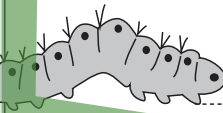
In dem großen R sind noch weitere 11 Wörter verborgen. Markiere sie und schreibe sie dann in die leeren Felder!

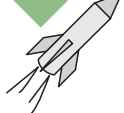
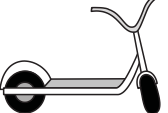
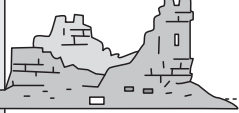
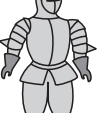

| | | | |
|---|-------|--|-------|
|  | Rose |  | _____ |
|  | _____ |  | _____ |
|  | _____ |  | _____ |
|  | _____ |  | _____ |
|  | _____ |  | _____ |
|  | _____ |  | _____ |

